

**3M** Science.  
Applied to Life.™



**3M™ RelyX™ Universal**  
Resin Cement

# Technical Product Profile

# Content

<b>1. Introduction to 3M™ RelyX™ Universal Resin Cement</b>	3
<b>2. Clinical experience</b>	10
<b>3. 3M™ RelyX™ Universal Automix Syringe</b>	12
<b>4. Chemical compositions</b>	14
<b>5. Paste rheology</b>	15
<b>6. Excess clean-up</b>	16
<b>7. Bonding performance</b>	17
<b>8. Esthetic properties</b>	18
<b>9. Radiopacity</b>	23
<b>10. Summary of physical and mechanical properties</b>	23

## 1. Introduction to 3M™ RelyX™ Universal Resin Cement

3M™ RelyX™ Universal Resin Cement is a two-paste resin cement for virtually all self-adhesive and – when used with 3M™ Scotchbond™ Universal Plus Adhesive – adhesive dual-cure resin cement indications.

It comes in the game-changing **3M™ RelyX™ Universal Automix Syringe** and is available in four color-stable, fluorescent shades. Other benefits include easy excess clean-up, excellent bond strength in light- and self-cure, and virtually no post-op sensitivity.

Used alone, RelyX Universal Resin Cement delivers excellent self-adhesion to zirconia, metal and enamel plus **superior self-adhesive bond strength to dentin**. Most cases can be handled without any adhesive or primer. Combined with Scotchbond Universal Plus Adhesive, it allows bonding to glass ceramics and enhanced bond strength to all substrates, for cases that demand maximum bond strength.

Scotchbond Universal Plus Adhesive builds on Scotchbond Universal Adhesive. It works as a self-, selective- and total-etch adhesive for direct and indirect restorations. Its dentin-like radiopacity reduces the risk of misdiagnosing secondary caries, marginal gaps or voids. It is also a universal primer for all restoration materials.

RelyX Universal Resin Cement and Scotchbond Universal Plus Adhesive add up to **a true two-component system**. Two components that do it all mean fewer products on hand, less risk of error, less stress, more savings and clear, standardized procedures.

- Hygienic, self-sealing syringe minimizing plastic and cement waste
- Easy excess clean-up
- Superior self-adhesive bond strength to dentin
- High esthetics with four fluorescent shades
- First radiopaque all-in-one universal adhesive
- Further boosts bond strength of RelyX Universal Resin Cement
- Fully aligned system: adhesive cured by cement, no light cure needed
- Universal primer for all restorative materials

BPA derivative free formulations

Translucent (TR)    A1    A3 Opaque (A3O)    White Opaque (WO)

# Truly universal

## Covers virtually all dual-cure resin cement indications



## Covers the full spectrum of restorative materials

3M™ RelyX™ Universal Resin Cement offers excellent self-adhesion to zirconia, metal and 3M™ RelyX™ Fiber Posts. Bond strength can be further enhanced with 3M™ Scotchbond™ Universal Plus Adhesive which also serves as a universal primer for all restorative materials including glass ceramics.

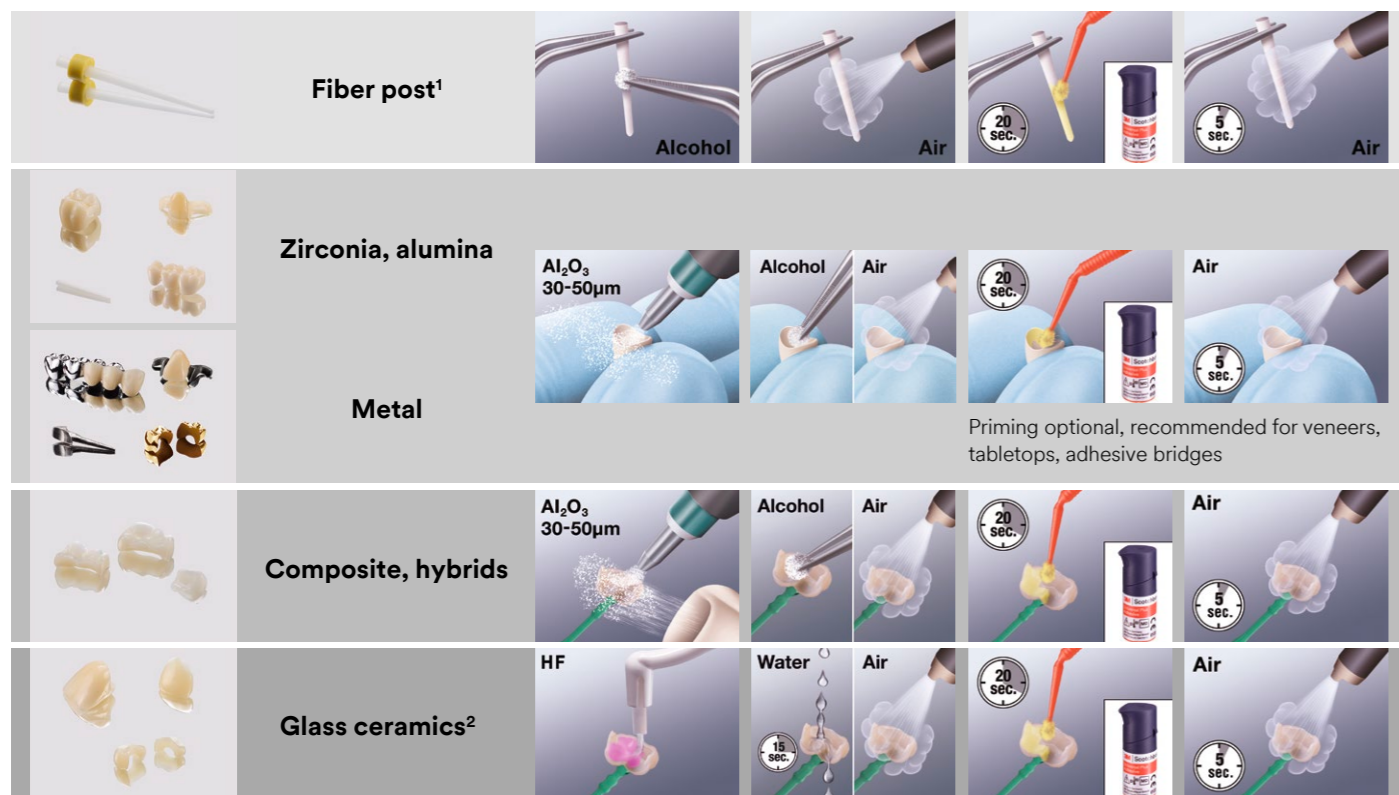

<sup>1</sup> Priming not required for 3M™ RelyX™ Fiber Posts | <sup>2</sup> Alternative primer: Apply a Silane, e.g. 3M™ RelyX™ Ceramic Primer

## Allows usage as adhesive and as self-adhesive resin cement

The self-adhesive properties of 3M™ RelyX™ Universal Resin Cement, combined with the self-etch, selective-etch and total-etch adhesive capabilities of 3M™ Scotchbond™ Universal Plus Adhesive, allow you to treat cases with maximized efficiency.

### Tooth pre-treatment options

#### Option 1: Self-adhesive

Recommended for:

- Post
- Crown
- Bridge



Adhesive not required on tooth

#### Option 2: (Selective-etch) adhesive

Recommended for:

- Inlay
- Onlay



Optional for cut enamel

#### Option 3: Total-etch adhesive

To be used for:

- Tabletop
- Veneer
- Adhesive bridge



### Seating of restoration

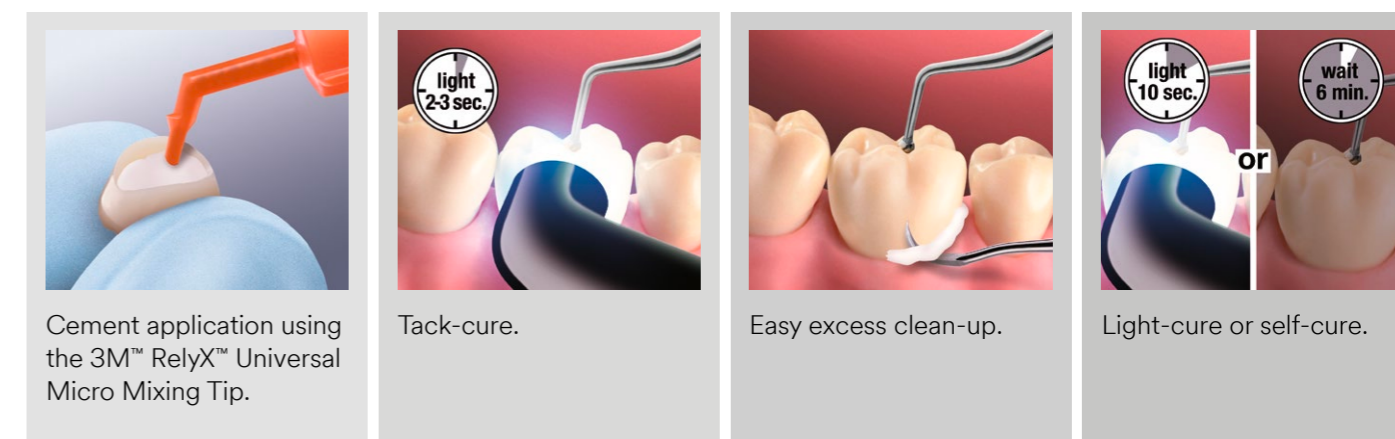

# Clinical case examples

## Self-adhesive cementation of a zirconia crown

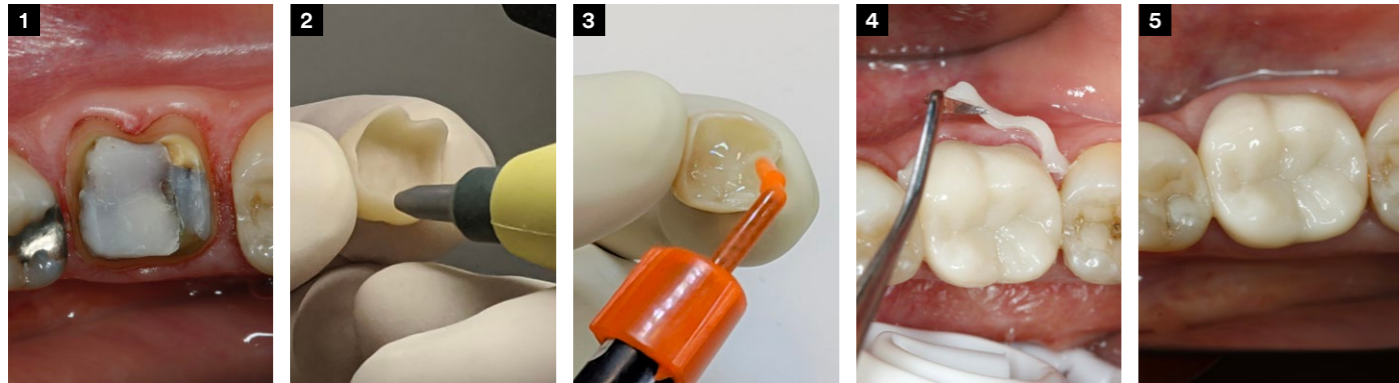

1 Preparation. 2 Sandblasting of bonding surface after final try-in. 3 Application of 3M™ RelyX™ Universal Resin Cement. 4 Easy excess clean-up after tack-curing. 5 Final situation.

Photo courtesy of Dr. Gunnar Reich, Germany

## Total-etch adhesive bonding of glass ceramic veneers

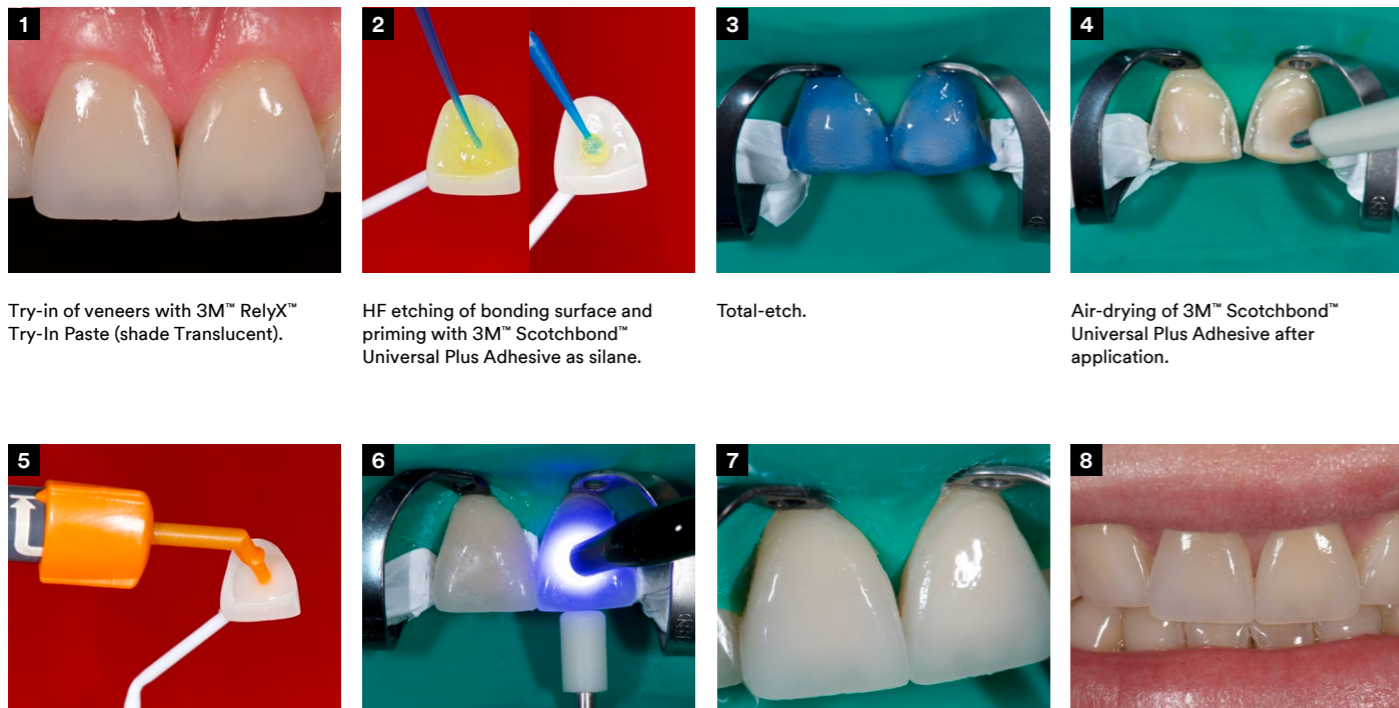

1 Try-in of veneers with 3M™ RelyX™ Try-In Paste (shade Translucent). 2 HF etching of bonding surface and priming with 3M™ Scotchbond™ Universal Plus Adhesive as silane. 3 Total-etch. 4 Air-drying of 3M™ Scotchbond™ Universal Plus Adhesive after application. 5 Application of 3M™ RelyX™ Universal Resin Cement (shade Translucent). 6 Initial attachment with pinpoint light guide. 7 Both veneers in place after clean-up. Note the perfect marginal integration of the ceramic and enamel. 8 Final situation.

Photo courtesy of Dr. Rafal Mędzin, Poland

## Selective-etch adhesive cementation of chairside CAD/CAM glass ceramic inlays

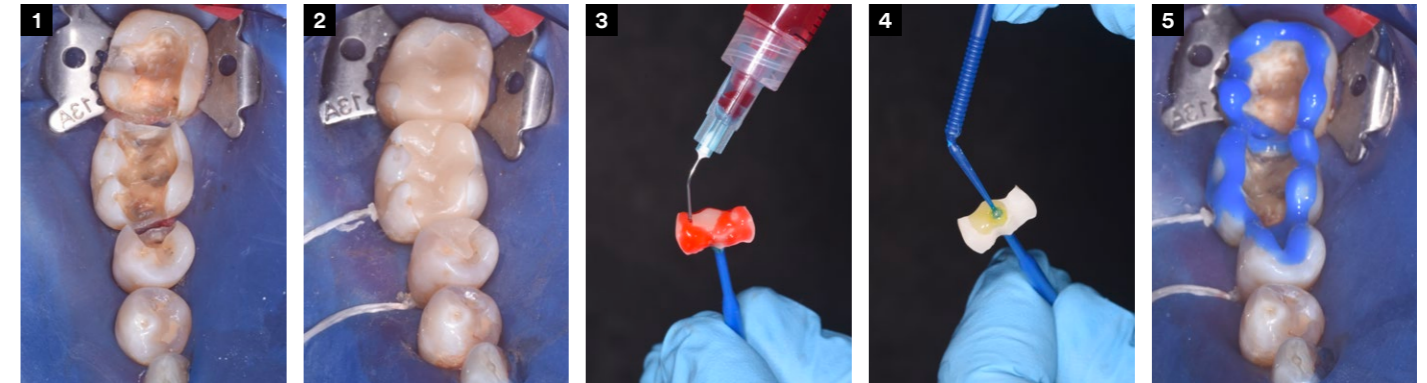

1 Preparations. 2 Try-in of inlays. 3 HF etching. 4 Application of 3M™ Scotchbond™ Universal Plus Adhesive as silane primer. 5 Selective enamel etching.

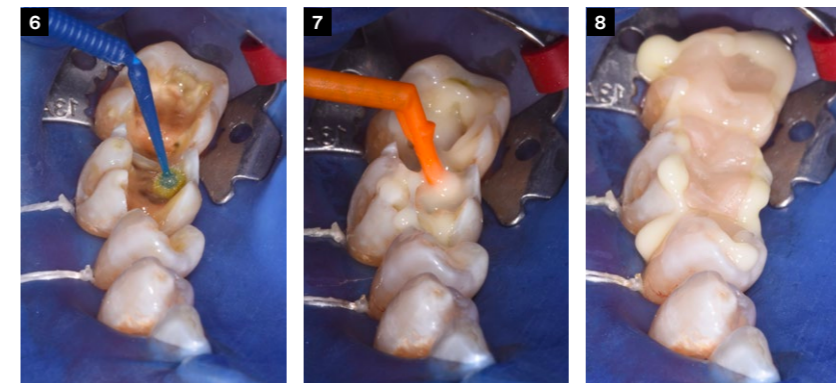

6 Application of 3M™ Scotchbond™ Universal Plus Adhesive. 7 Application of 3M™ RelyX™ Universal Resin Cement into the cavities. 8 Right after placement – cement excess stays put for easy excess removal.

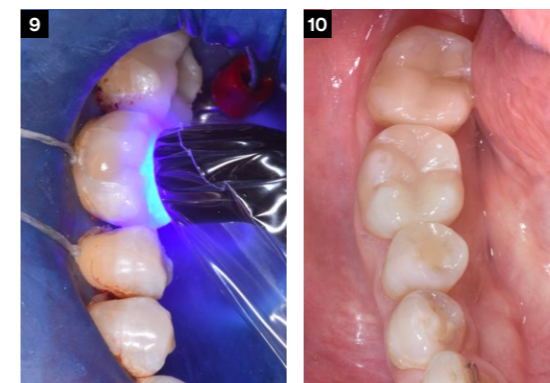

9 Final light cure with 3M™ Elipar™ DeepCure LED Curing Light after excess clean-up. 10 Final situation right after placement.

Photo courtesy of Dr. Stergios Zafiriadis, Switzerland



## 2. Clinical experience

**123 dentists from five countries** used the 3M™ RelyX™ Universal Resin Cement in a field evaluation conducted by 3M. The universality of the system was fully put into play by the participants. **3,806 restorations across the whole indication spectrum** were placed employing both the adhesive mode together with 3M™ Scotchbond™ Universal Plus Adhesive as well as the self-adhesive mode of RelyX Universal Resin Cement.

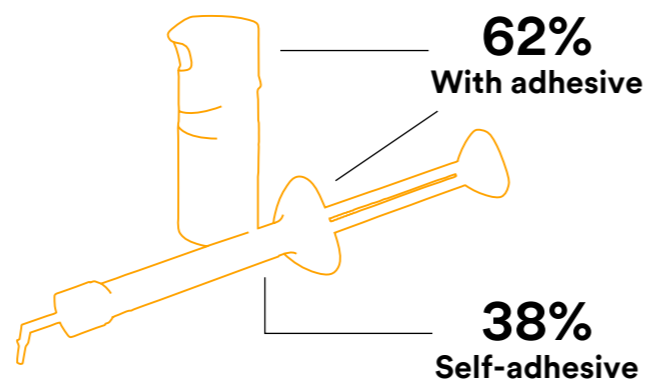

**3,806 restorations across the whole indication spectrum**

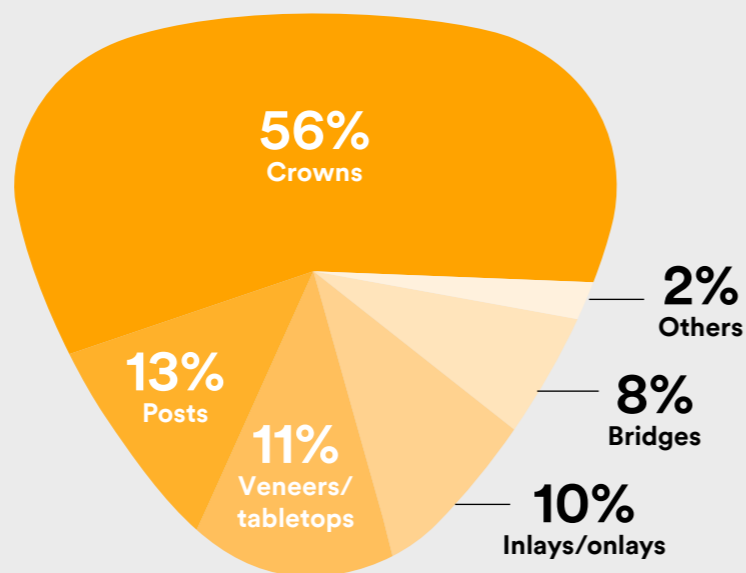

**Virtually no post-op sensitivities**

**99%**  
of dentists **did not observe post-operative sensitivities**



**High overall satisfaction**

**98%**  
of dentists were **very satisfied or satisfied with the cement system overall**

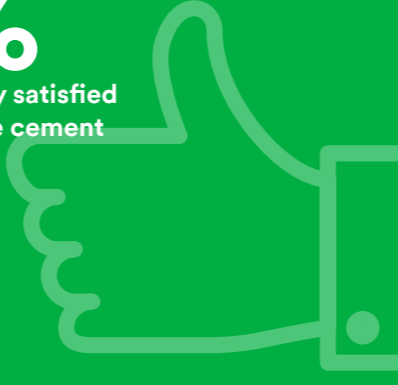

## What dentists are saying

**Simplified, cost-saving workflows**

**93%**  
of dentists agreed 3M™ RelyX™ Universal Resin Cement **simplifies resin cement workflows**

**95%**  
of dentists agreed the universal character of 3M™ RelyX™ Universal Resin Cement helps to **reduce stock and save costs**

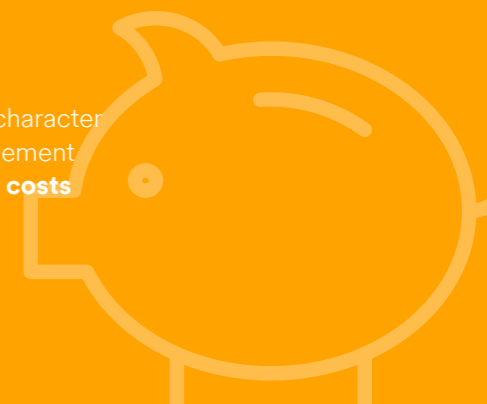

**Easier to train, easier to use**

**93%**  
of dentists agreed using 3M™ RelyX™ Universal Resin Cement **simplifies the training** of operator personnel

**97%**  
of dentists agreed using **one universal versus multiple resin cements** is easier for operator staff



**Game-changing 3M™ RelyX™ Universal Automix Syringe**

**97%**  
of dentists **were very satisfied or satisfied** with the innovative 3M™ RelyX™ Universal Automix Syringe



Source: Field Evaluation EU/USA conducted by 3M

# 3. 3M™ RelyX™ Universal Automix Syringe

## Hygienic, self-sealing design.

The 3M™ RelyX™ Universal Micro Mixing Tip is removed right after use – enabling hygienic storage without used mixing tip. The syringe is cleanly sealed by a unique valve mechanism.



## Only two mixing tip components.



The **Micro Mixing Tip** provides excellent mixing quality.

A thin, long and flexible **elongation tip** offers easy cement application into the root canal.

Proprietary 3M design

## 50% less plastic waste.\* 15 applications.\*\*

The small, ergonomic 3.4g syringe delivers the usual number of applications with half the plastic waste.

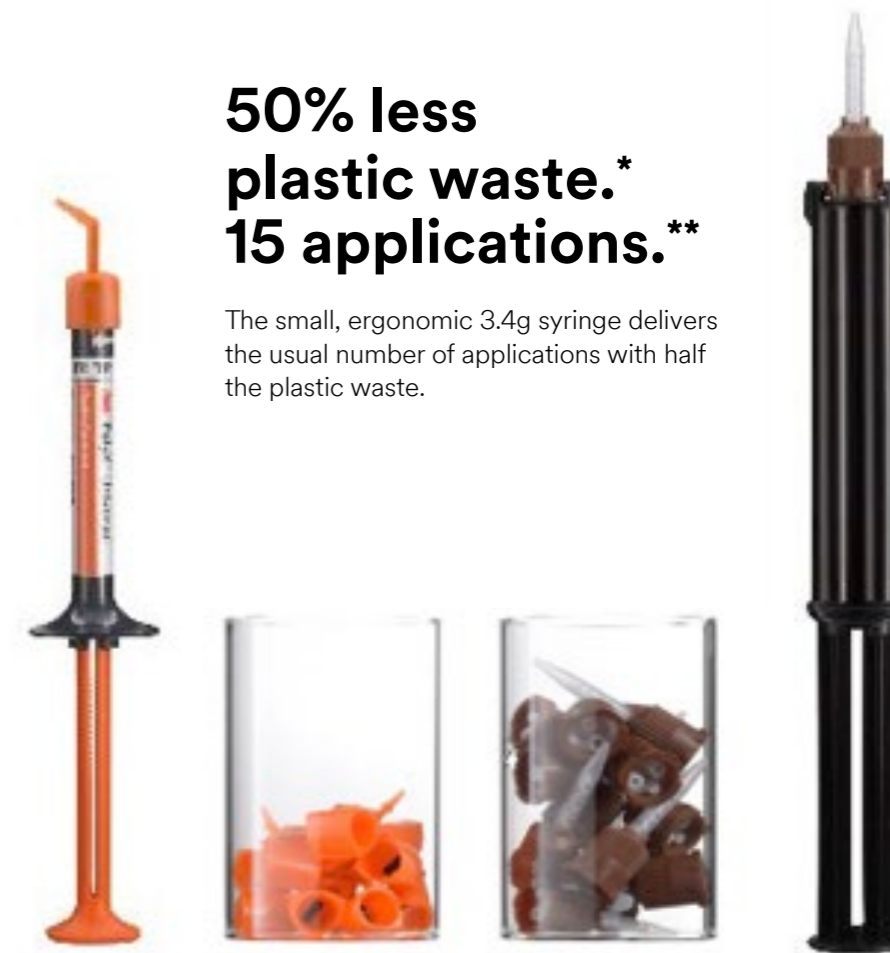

## 80% less cement waste\* with Micro Mixing Tip.

Thanks to the unique and innovative mixing tip design, paste waste has been significantly reduced.

## More ergonomic. Easier to clean.\*\*\*

94%

of dentists agreed the 3M™ RelyX™ Universal Automix Syringe is **more ergonomic** than current automix syringes

90%

of dentists agreed the 3M™ RelyX™ Universal Automix Syringe is **easier to clean** than current automix syringes

Source: Field Evaluation EU/USA conducted by 3M

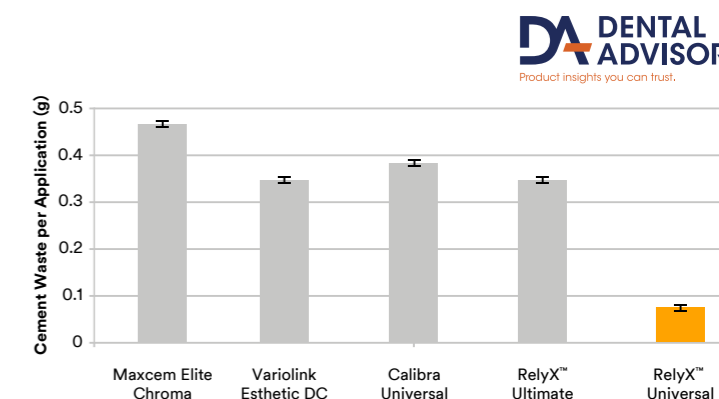

Fig. 1: Comparison of cement waste per application.

Source: M. Cowen, J.M. Powers, The Dental Advisor, Number of Automix Applications and Mixing Efficiency, November 13, 2019

\* per application compared to currently available standard automix systems | \*\* on average | \*\*\* compared to currently used automix syringes

## 4. Chemical compositions

To enable the truly universal nature of 3M™ RelyX™ Universal Resin Cement a new chemical composition was developed. The two key achievements are the development of a unique amphiphilic redox initiator system and a new filler architecture.

The new initiator system enhances the self-cure bond strength especially to dentin (chapter 7) and is the key to the easy excess clean-up after tack-cure (chapter 6). The new fillers optimize the rheology for easy placement and clean-up (chapters 5 and 6) as well as offering improved radiopacity (chapter 8).

3M™ Scotchbond™ Universal Plus Adhesive keeps many components of Scotchbond Universal Adhesive. Careful adjustments have been made to allow for the new benefits of radiopacity, a BPA derivative free formulation, an improved bond to glass ceramics as well as improved dual-cure compatibility eliminating the need of a separate activator vial.

3M™ RelyX™ Universal Resin Cement
BPA derivative free dimethacrylate monomers
Phosphorylated dimethacrylate adhesion monomers
Photoinitiator system
Novel amphiphilic redox initiator system
Radiopaque fillers and rheological additives
Pigments

3M™ Scotchbond™ Universal Plus Adhesive
BPA derivative free dimethacrylate monomers including a novel radiopaque monomer
MDP Phosphate Monomer
HEMA hydrophilic monomer for wetting dentin
3M™ Vitrebond™ Copolymer - 3M proprietary technology for moisture tolerance
Non-settling silica filler for adjusting viscosity and handling
Ethanol
Water
Photoinitiator system
Optimized mixture of silanes for high bond to glass ceramics
Dual-cure accelerator

## 5. Paste rheology

Thanks to the altered filler composition and the addition of a specific rheology additive, 3M™ RelyX™ Universal Resin Cement has a low viscosity under pressure. This so-called thixotropic behavior results in a good flow behavior when the cement is extruded through the mixing tip as well as when the restoration is placed and the cement has to flow out of the cement gap. According to customer ratings, RelyX Universal Resin Cement provides the right viscosity for dispensing and easy seating of restorations.

As soon as the pressure decreases, the viscosity increases and the cement remains in place. This is clearly visible in Fig. 2 where RelyX Universal Resin Cement (at 36°C/96.8°F) does not flow down a vertical pad, even after 2 minutes.

This behavior ensures that cement excess stays at the restoration margins, rather than flowing into the sulcus. This is an important prerequisite for easy excess clean-up.

Easy seating of restorations.

# 100%

of dentists rated **placing the restoration safely on the tooth** as very easy or easy

Viscosity rating

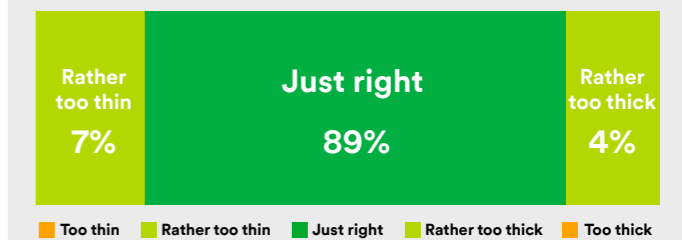

Source: Field Evaluation EU/USA conducted by 3M



Fig. 2: To compare the flow properties, equal amounts of each cement were applied on a pad which was stored upright at 36°C/96.8°C for 2 minutes before the cement was light-cured. Source: 3M internal data

## 6. Excess clean-up

Easy excess clean-up is a key customer requirement for resin cements and was one of the main development goals for 3M™ RelyX™ Universal Resin Cement.

Easy excess clean-up was achieved by optimizing the rheology and the initiator components. As described in chapter 5, the mixed paste flows easily while dispensing or seating the restoration but stays put when no pressure is applied. The excess outflow stays at the restoration margin ready for removal and does not flow away.

Secondly, the amount of photoinitiator was reduced, resulting in a lower paste stiffness after tack-curing that eases excess clean-up. To maintain and even improve the bond strength properties, the reduced photoinitiator content was compensated by a novel highly efficient self-cure initiator (chapter 7).



Seated crown with excess outflow.

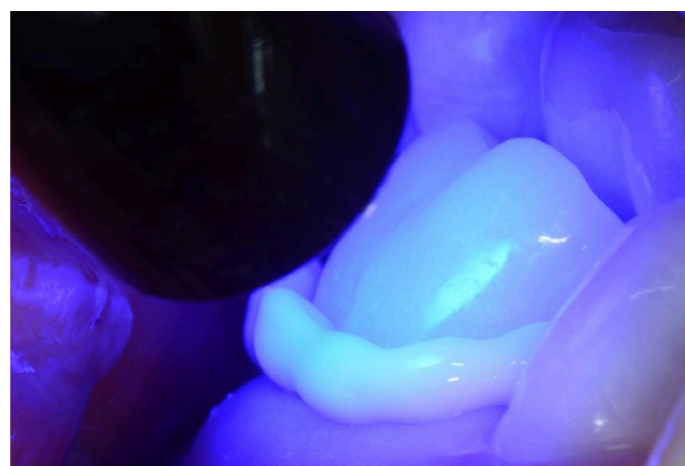

Tack-cure of cement excess.



Excess clean-up with probe.  
Photo courtesy of Dr. Giuseppe Chiodera, Italy

93%

of dentists agreed 3M™ RelyX™ Universal Resin Cement's **excess outflow stays put for an easier clean-up**

93%

of dentists rated **excess clean-up** of 3M™ RelyX™ Universal Resin Cement after tack-cure as **easy or very easy**

Source: Field Evaluation EU/USA conducted by 3M

## 7. Bonding performance

### The science behind the excellent bond strength

3M™ RelyX™ Universal Resin Cement contains amphiphilic adhesion monomers and a novel amphiphilic redox initiator system (AIS). The adhesion monomers diffuse into the hydrophilic dentin smear layer and form a strong bond to dentin. The novel amphiphilic initiator system can also

diffuse and function very efficiently at the dentin interface. A highly crosslinked 3D polymer network is formed. This enhances the bond strength to dentin and grants long-term stability.

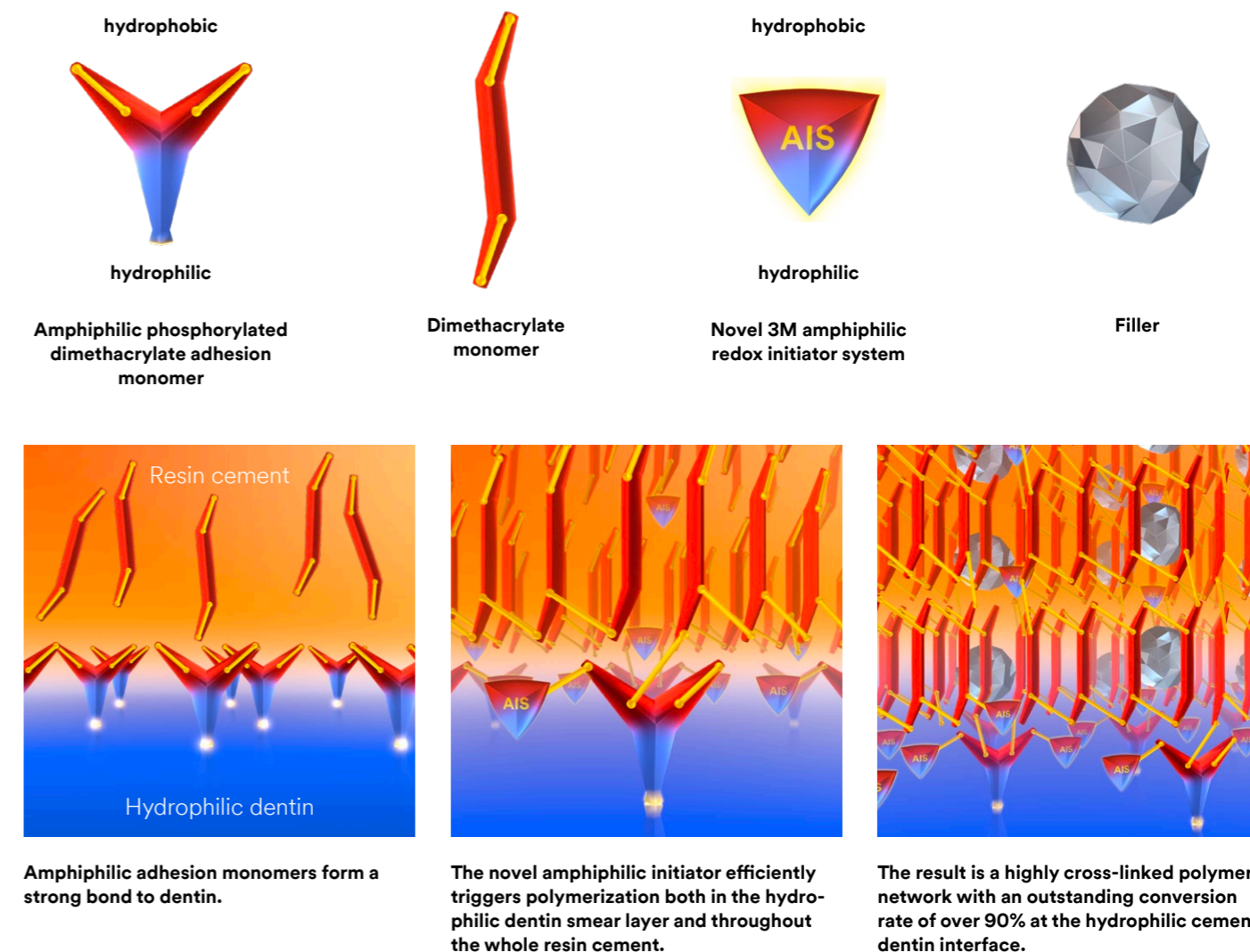

### What is amphiphilic?

Amphiphilic means a molecule contains both a hydrophilic part attracted to water and a hydrophobic part deflected from water. This enables the molecule to function in both hydrophobic and hydrophilic environments.



The effectiveness of initiators can be quantified by measuring the monomer conversion rate. Micro-Raman spectroscopy reveals that the novel amphiphilic initiator leads to an outstanding dimethacrylate monomer conversion rate of more than 90% in the dentin smear layer (Figs. 4 and 5).

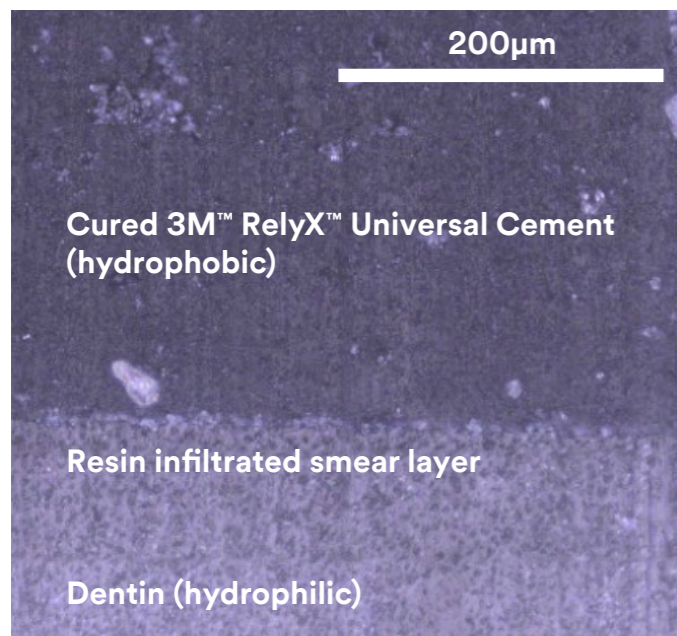

Fig. 4: SEM image of the dentin/cement interface showing the resin infiltrated smear layer. Source: 3M internal data

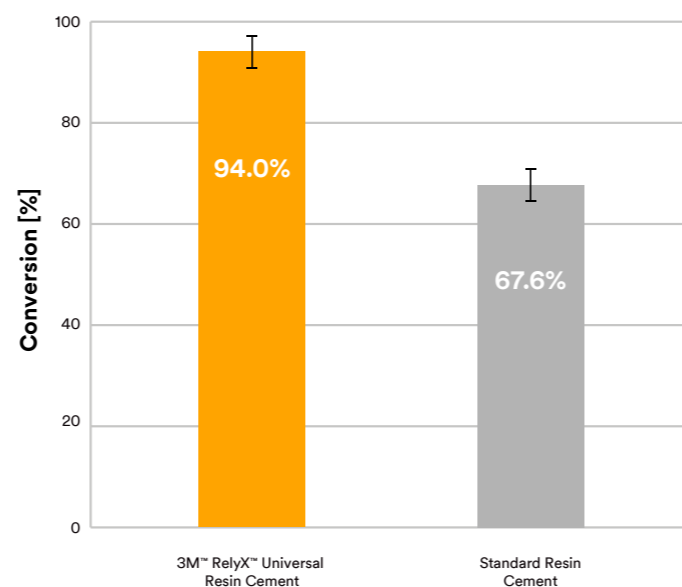

Fig. 5: Dimethacrylate conversion rate at dentin/cement interface determined by Micro-Raman spectroscopy. Source: 3M internal data

### Self-adhesive bond strength to dentin

This shear bond strength test revealed that 3M™ RelyX™ Universal Resin Cement offers superior self-adhesive bond strength to dentin which is stable to artificial aging (Fig. 6). Due to the novel initiator system, RelyX Universal Resin

Cement offers reliable bond strength performance even without light-cure. The bond strength is equivalent in both light-cure and self-cure modes.

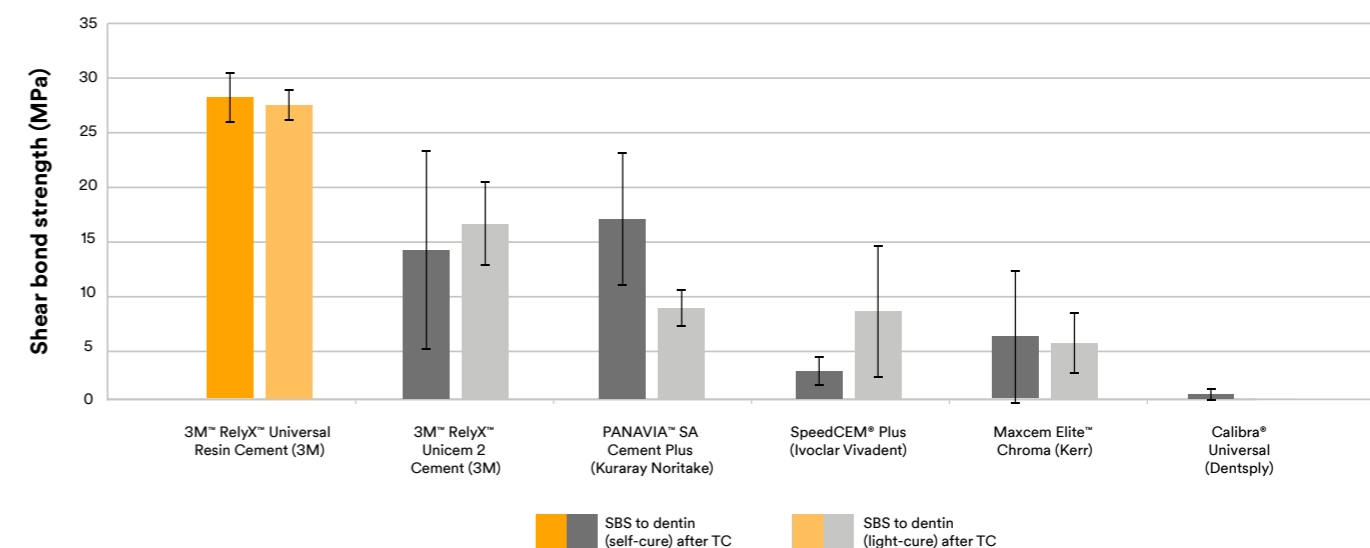

Fig. 6: Shear bond strength to dentin after artificial aging by thermocycling (5,000 cycles, 5°C-55°C). Excerpt from R. Afutu, M. Abreu, G. Kugel; Tufts University School of Dental Medicine, Boston, Massachusetts, United States., J. Dent. Res. Vol 98A, No 3629, 2019

### Bond strength to zirconia

Featuring phosphorylated adhesion monomers, RelyX Universal Resin Cement exhibits high self-adhesion to zirconia. With the MDP primer contained in 3M™ Scotchbond™ Universal Plus Adhesive the bond strength can be further enhanced.

RelyX Universal Resin Cement together with Scotchbond Universal Plus Adhesive as primer showed significantly higher bond strength to zirconia in self-cure mode compared to Panavia™ V5 with Clearfil™ Ceramic Primer (Fig. 7). RelyX Universal Resin Cement used in self-adhesive mode delivered equivalent bond strength to Panavia V5/Clearfil Ceramic Primer while saving the primer step.

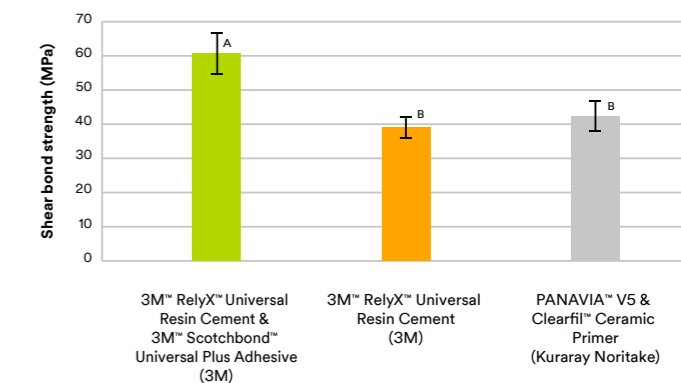

Fig. 7: Self-cure shear bond strength to zirconia after 24h storage at 36°C/96.8°F in 100% relative humidity.

Excerpt from: Shear Bond Strength of a Novel Resin Cement to Zirconia, C. E. Sabrosa<sup>1</sup>, K. Geber<sup>1</sup>, S. Vandeweghe<sup>2</sup>, <sup>1</sup> Clínica Odontológica Dr Sabrosa, Rio de Janeiro, Brazil, <sup>2</sup> Ghent University, Ghent, Belgium, J. Dent. Res. Vol 99A, No 1838, 2020



### Adhesive bond strength to enamel

The already high bond strength of 3M™ RelyX™ Universal Resin Cement can be further enhanced with 3M™ Scotchbond™ Universal Plus Adhesive.

In this test, RelyX Universal Resin Cement used together with Scotchbond Universal Plus Adhesive shows equivalent bond strength to enamel compared to Multilink® Automix and significantly higher values than Variolink® Esthetic/Adhese® Universal. Scotchbond Universal Plus Adhesive was not light-cured whereas Adhese Universal and all cements were light-cured (Fig. 8).

The RelyX Universal Cement/Scotchbond Universal Adhesive Plus system saves the light-curing step compared to Variolink Esthetic/Adhese Universal. Compared to Multilink Automix and Primer A+B it saves one component and the primer mixing step. The data suggests that the workflow simplification versus the two comparison products comes without a trade-off in bond strength.

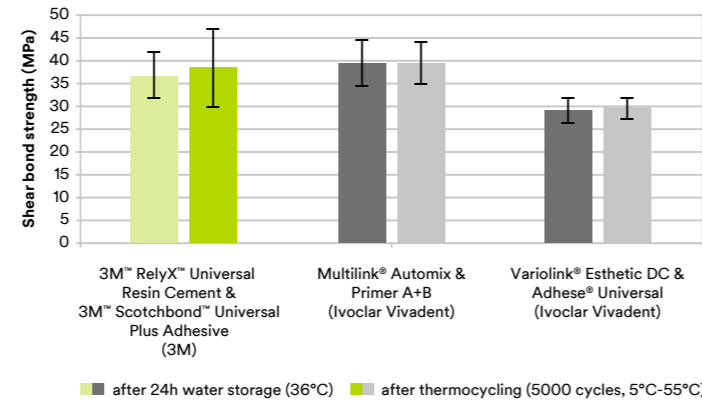

Fig. 8: Light-cure shear bond strength to enamel after 24 hours and after artificial aging by thermocycling (5.000 cycles, 5°C-55°C).

Source: K. Claussen, M. Ludsteck, S. Hader, R. Hecht, 3M Oral Care, 3M Deutschland GmbH, Seefeld, Germany, J. Dent. Res. Vol 99A, No 2785, 2020

### Bond strength to glass ceramics

For bonding to glass ceramic restorations with RelyX Universal Resin Cement a silane primer is needed. Scotchbond Universal Plus Adhesive is the recommended primer and contains enhanced silanes which improve the bond strength to glass ceramics compared to RelyX Ultimate Adhesive Resin Cement with Scotchbond Universal Adhesive.

Bond strength to HF etched IPS e.max® CAD glass ceramic of RelyX Universal Resin Cement with Scotchbond Universal Plus Adhesive as the silane was found equivalent to Variolink® Esthetic with Monobond® Plus Primer (Fig. 9).

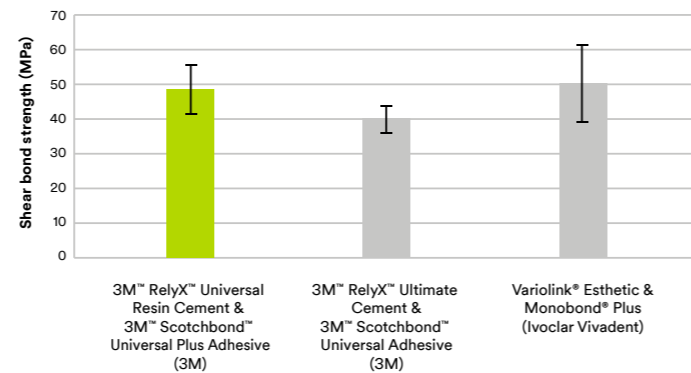

Fig. 9: Light-cure shear bond strength to HF etched IPS e.max® CAD glass ceramic after 24h storage at 36°C/96.8°F in 100% relative humidity.

Excerpt from: Shear Bond Strength of a Novel Adhesive Resin Cement to Glass Ceramic: K. Geber<sup>1</sup>, S. Vandeweghe<sup>2</sup>, A. Patel<sup>3</sup>, C.E. Sabros<sup>2</sup>, <sup>1</sup>Clinica Odontológica Dr. Sabrosa, Rio de Janeiro, Brazil, <sup>2</sup>Ghent University, Ghent, Belgium, <sup>3</sup>UCL Eastman Dental Institute, UK, J. Dent. Res. Vol 98B, No 327, 2019

### Cross comparison study of bond strength to multiple substrates

This Dental Advisor study confirms that 3M™ RelyX™ Universal Resin Cement used with 3M™ Scotchbond™ Universal Plus Adhesive shows excellent bond strength to dentin, enamel, zirconia and glass ceramic (Fig. 10).

The self-adhesive bond strengths of RelyX Universal Resin Cement to dentin, enamel and zirconia substrates are the highest of any self-adhesive cement tested.

The adhesive bond strengths of RelyX Universal Resin Cement together with Scotchbond Universal Plus Adhesive to dentin, enamel, and glass ceramic are on par with Variolink® Esthetic with the corresponding adhesive and primer. RelyX Universal Resin Cement used with Scotchbond Universal Plus Adhesive showed the highest bond strength values to zirconia among the materials tested.

#### Dentin

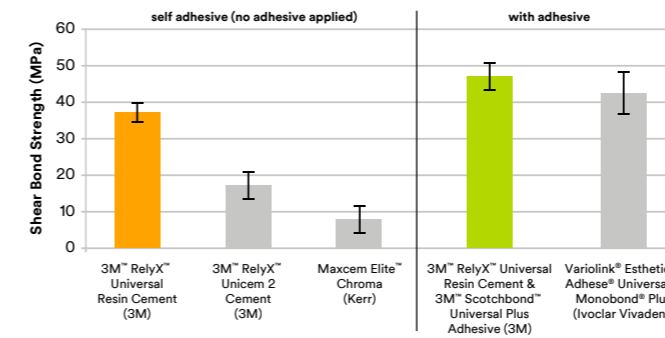

#### Zirconia

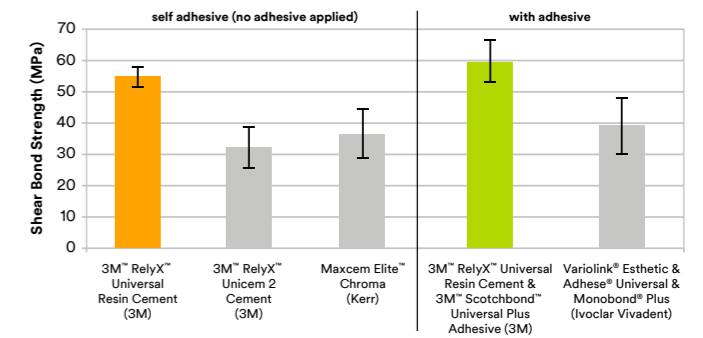

#### Enamel

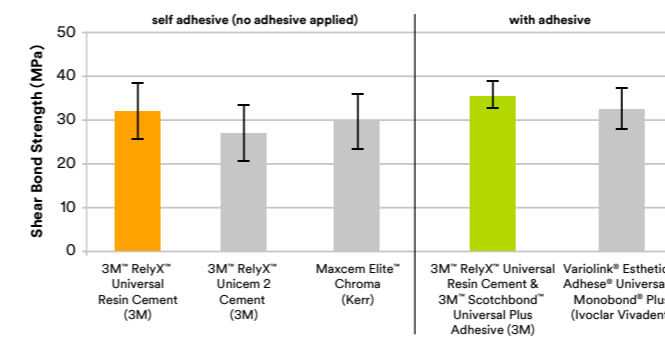

#### Glass ceramic

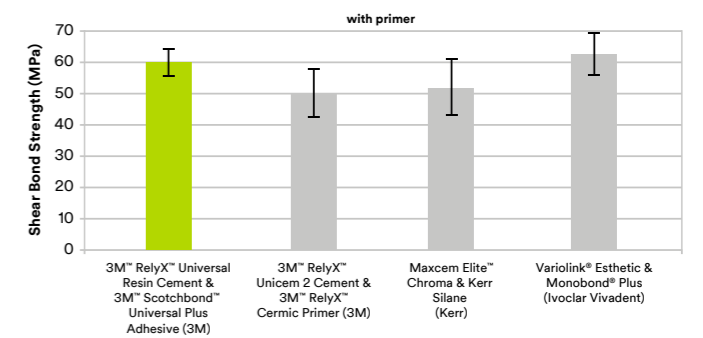

Fig. 10: Self-cure shear bond strengths to dentin, enamel, sandblasted 3M™ Lava™ Esthetic Fluorescent Full-Contour Zirconia and HF etched IPS e.max® CAD glass ceramic after 24h storage in 37°C/98.6°F deionized water.

Source: M. Powers, Dental Advisor, January 2020, Dental Advisor Report, January 29, 2020

# 8. Esthetic properties

## Tooth-like fluorescence

3M™ RelyX™ Universal Resin Cement shades show comparable fluorescence to human teeth to provide natural esthetic appearance (Fig. 11).

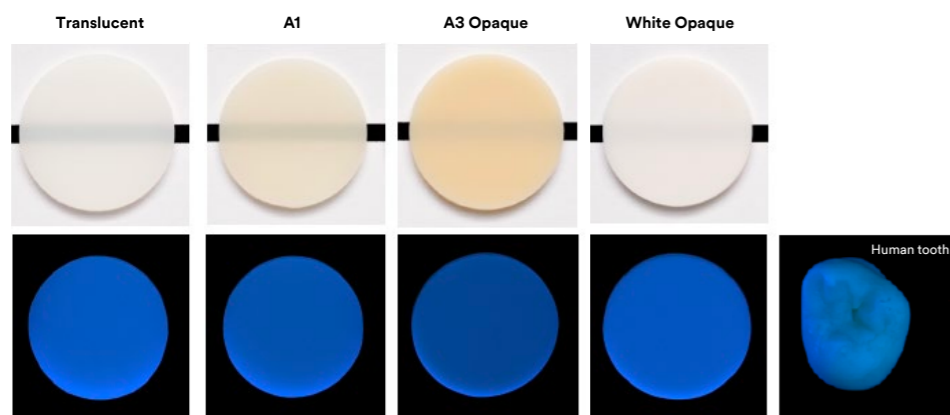

Fig. 11: 3M™ RelyX™ Universal Resin Cement shades show fluorescence close to human teeth under UVA light.

Source: 3M internal data

## Shade match with 3M™ RelyX™ Try-In Pastes

To facilitate the selection of the cement shade for high esthetic cases, the shades of RelyX Universal Resin Cement match with the corresponding RelyX Try-In Pastes (Fig. 12).

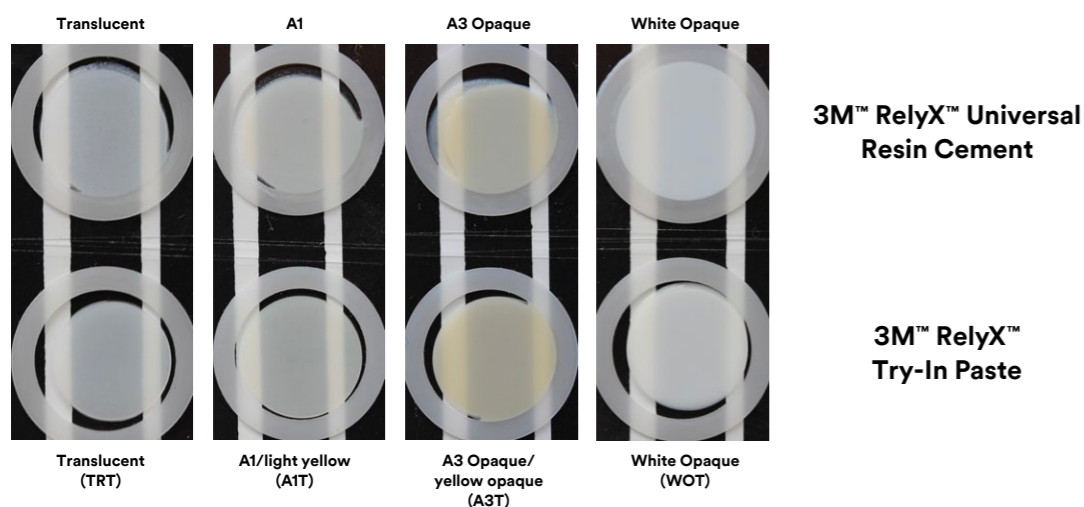

Fig. 12: Pictures of 3M™ RelyX™ Universal Resin Cement discs in comparison to 3M™ RelyX™ Try-In Paste layers of same thickness.

Source: 3M internal data

## Color stability

3M™ RelyX™ Universal Resin Cement shades show high color stability in a light exposure test conducted according to ISO 4049 (Fig. 13).

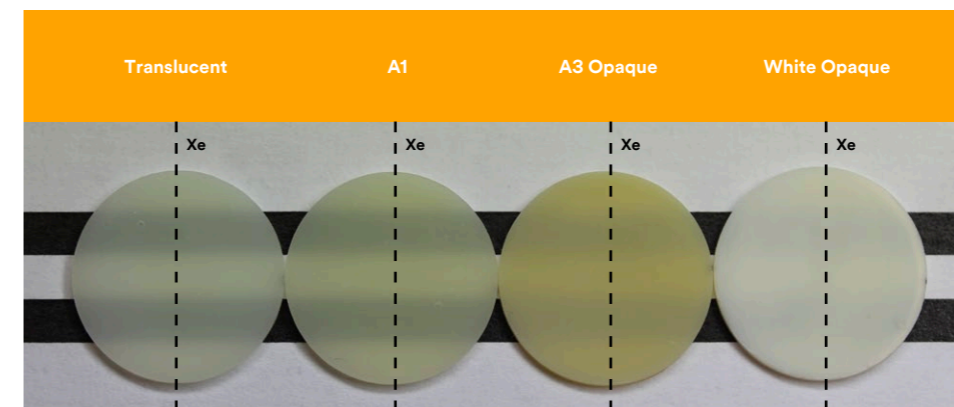

Fig. 13: Color stability under Xenon light. The left side of the disc was shielded from Xenon light, the right side was exposed.

Source: 3M internal data, light exposure test according to ISO 4049

## Discoloration stability

To simulate a cement gap, a 150 µm cement layer was prepared between two zirconia discs. Specimens were then stored in coffee for 24h at 36°C/96.8°F.

RelyX Universal Resin Cement shows no discoloration after 24 hours of storage in coffee while Maxcem Elite™ Chroma, Variolink® Esthetic and PANAVIA™ V5 have discolorations (Fig. 14).

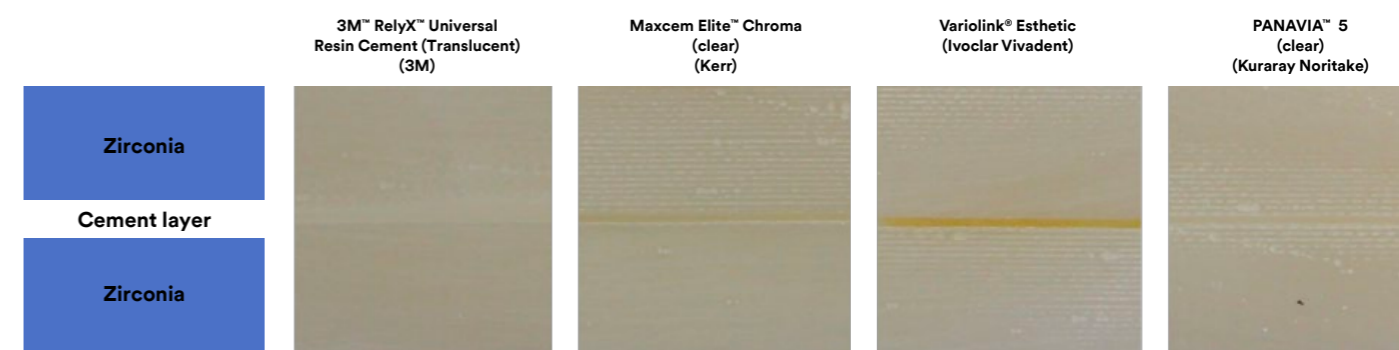

Fig. 14: Discoloration of cement layers after 24 hours of storage in coffee solution.

Source: 3M internal data

# 9. Radiopacity

The optimized filler technology of 3M™ RelyX™ Universal Resin Cement offer an improvement in radiopacity compared to 3M™ RelyX™ Ultimate Adhesive Resin Cement.

RelyX Universal Resin Cement has a radiopacity of 251% in comparison to aluminum standard, or 2.51 times the ISO 4049 requirement.

Radiopacity of RelyX Universal Resin Cement is higher than that of enamel which eases identifying the cement layer on radiographs (Fig. 15).

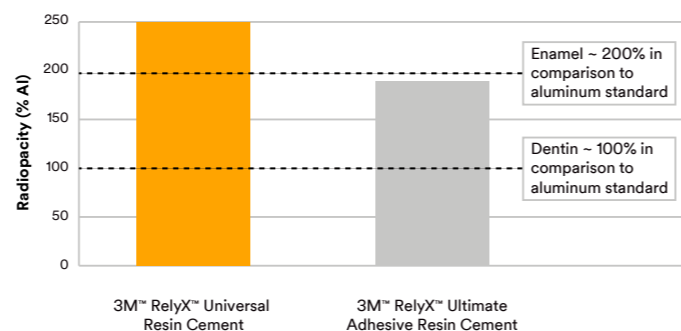

Fig. 15: Radiopacity of 3M™ RelyX™ Universal Resin Cement compared to 3M™ RelyX™ Ultimate Adhesive Resin Cement according to DIN EN ISO 4049. Source: 3M internal data

# 10. Summary of physical and mechanical properties

	Value
Film thickness [µm]*	21
Depth of cure [mm]*	2.9
Flexural strength [MPa]*	100
Compressive strength [MPa]**	312
Water sorption [µg/mm³]*	29
Solubility [µg/mm³]*	-0.1
Expansion after 1 month [%]	0.7

\* acc. to DIN EN ISO 4049 \*\* Measurements were done following DIN ISO 9917-1:2008

Fig. 16: Physical and mechanical properties of 3M™ RelyX™ Universal Resin Cement. Source: 3M internal data



**3M Deutschland GmbH**  
ESPE Platz · 82229 Seefeld  
Germany  
info3mespe@mmm.com  
www.3M.com

**3M.com**

3M and RelyX are trademarks of 3M Company or 3M Deutschland GmbH. Used under license in Canada. All other trademarks are owned by other companies.  
© 3M 2020. All rights reserved.